

Submersible motors for screw centrifugal pumps

Dry-installed Hidrostal submersible pumps are efficient, robust and reliable – a tailor-made solution for every application.



Hidrostal Tuma motor line

The new Hidrostal motors are available with drive power from 10 – 200 kW and are suitable for vertical and horizontal installation. Thanks to the IP68 construction, the motor pumps can be used in flooded permanent operation, but also in dry installation. Cooling is ensured by an internal energy-efficient cooling circuit.

These characteristics make Tuma motors the ideal drive for screw centrifugal pumps to pump untreated wastewater, sludge or other demanding media.

In addition to different speeds and voltages the insulation classes and construction materials can be freely selected. Various protection and monitoring elements ensure maximum safety and durability.



Pump with highly efficient Tuma submersible motor from Hidrostal

The motor line bears the name of the source of the Rhine, the Lai da Tuma. The transformation of a crystal-clear mountain lake into a raging river inspired us to develop a compact, streamlined pump that offers extensive performance potential. This impressive natural requirement was our teacher in designing these motors and producing them in a particularly sustainable way.

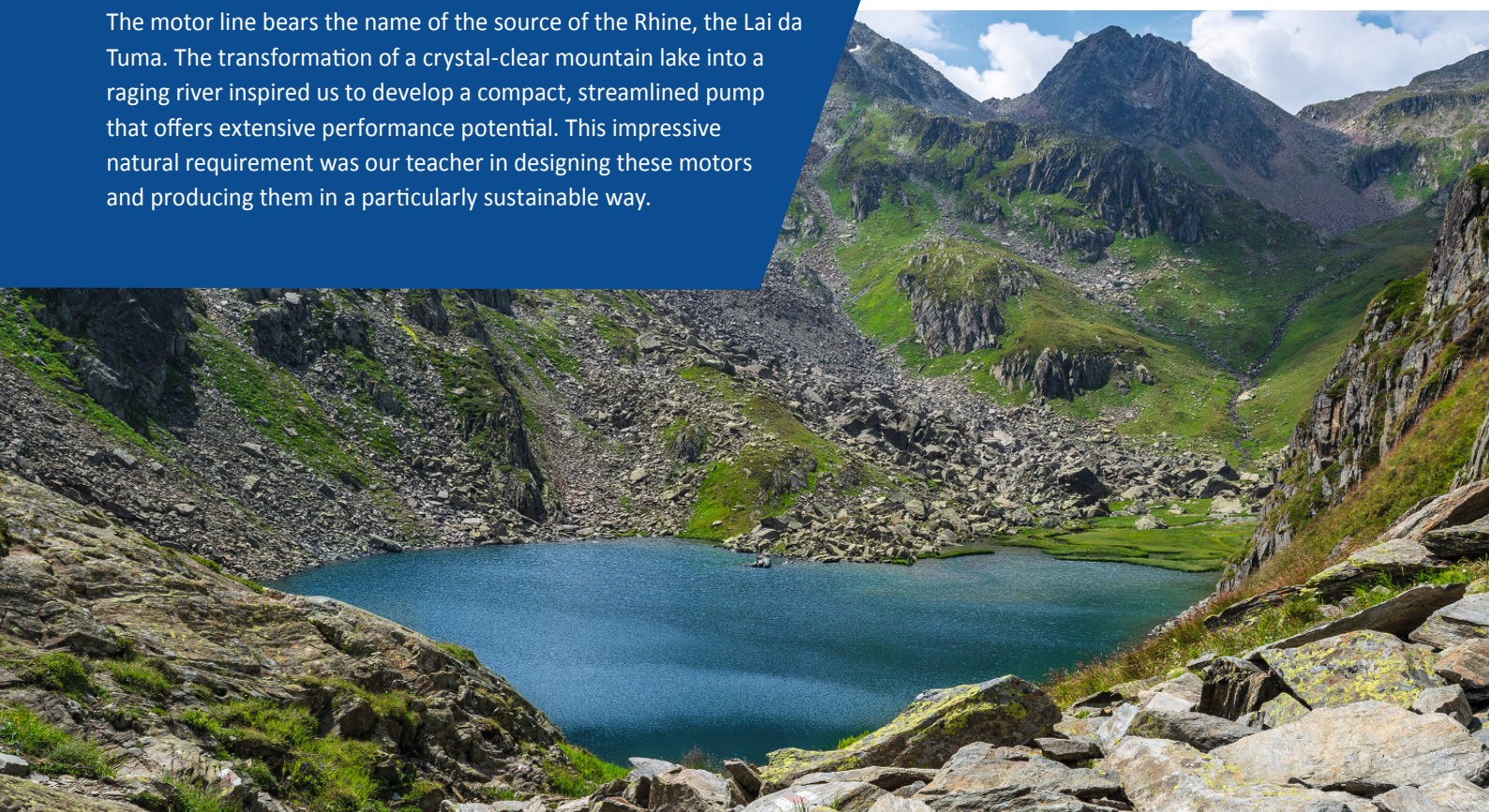

Efficiency and sustainability

Hidrostal Tuma motors ensure premium efficiency to minimize the total cost of ownership for the entire life cycle of the pump.

Although submersible motors are excluded from IEC efficiency classes due to their design, our pumps nevertheless achieve IE3-equivalent premium efficiency.

Another special feature is that this premium efficiency is achieved with sustainable production and the complete elimination of rare earths.

The robustness, wear resistance and durability of the individual components also ensure that the pumps have an extremely long product life cycle.

All these features combined with an energy-efficient Hidrostal screw centrifugal pump, result in the most economical solution on the market.

Standard Specifications

- Performance: 10 – 200 kW
- IEC Mud sizes: 180 – 315
- Speed: 375 – 3600/min
- Protection class: IP68 up to 40 m immersion depth
- Frequencies: up to 66 Hz
- Insulation class: F and H
- Voltages: 220 – 690 V
- Operating mode: continuous operation (S1)

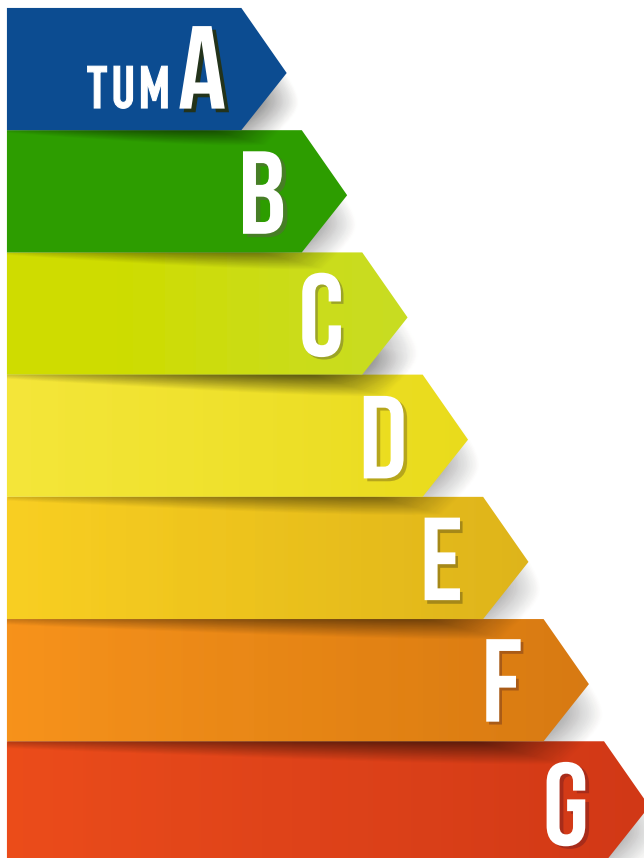

Outstanding design features

Functional design

The streamlined surface of the motor prevents solids from adhering to the housing. Only a few cutting sites are required during manufacture, making cleaning much easier and significantly reducing the risk of corrosion. The design, taking into account the Poka Yoke principle, ensures simple and fast service and maintenance work. The guaranteed maximum immersion depth of 40 meters is unmatched in the application segment.

Innovative cooling system robust and closed

The innovative and patented integral cooling system forms a robust, closed circuit. The coolant flows around all electrically active components and bearings. It is circulated by a highly efficient cooling impeller which is located directly on the shaft. Due to the active cooling of the bearings, extremely gentle operation and longer grease service lives are achieved.

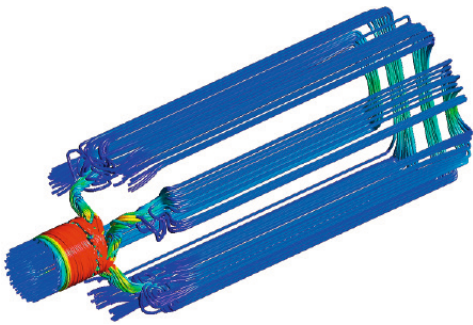

Robust bearing

In the Tuma motors, the shaft overhang has been heavily minimized to reduce the forces acting on the bearings. The robust bearings have a minimum service life of 50 000 operating hours (L10h). As an additional safety feature, Tuma motors have emergency plain bearings. To prevent stray currents, ceramic bearings are standard from 75 kW and optional for smaller sizes.

Cable connector

Hidrostral motors are equipped with longitudinally sealed cable entries. In the Tuma motors, the entries are pluggable and can be decoupled from the motor for service purposes. The high-quality duplex cable entries are fitted with hybrid cables, which combine power and control wires in a completely shielded manner.



Versatility is our strength

Whether for applications in floodable areas, for dry installation or for variable level – for every application we offer the most suitable motor with optimum performance. The different material designs guarantee reliable operation even for difficult applications. Tuma motors are also approved for use in potentially explosive environments. The stainless steel design ensures maximum corrosion resistance, especially in demanding applications.

The extensive monitoring options allow safe operation of the motors. With our many years of experience in the construction of electric motors, we can produce any motor that is optimally tailored to your requirements.

- 1 Wave polygon
- 2 Double mechanical seal in tandem arrangement various options for mechanical seals on the medium side
- 3 Efficient coolant circulation wheel
- 4 Float switch, leakage monitoring motor compartment
- 5 Conductivity probe for monitoring the mechanical seal
- 6 Bearing temperature monitoring below
- 7 Electrical components with premium efficiency class
- 8 Coolant circulation
- 9 Winding temperature monitoring
- 10 Preloaded deep groove ball bearing
- 11 Separate pluggable cable covers
- 12 Longitudinal sealed cable bushing
- 13 Motor compartment flameproof encapsulated for explosive environments
- 14 Heavy-duty clearance-free bearing
- 15 Blocking medium and coolant, large barrier medium chamber
- 16 Sealing part with heat exchange surface

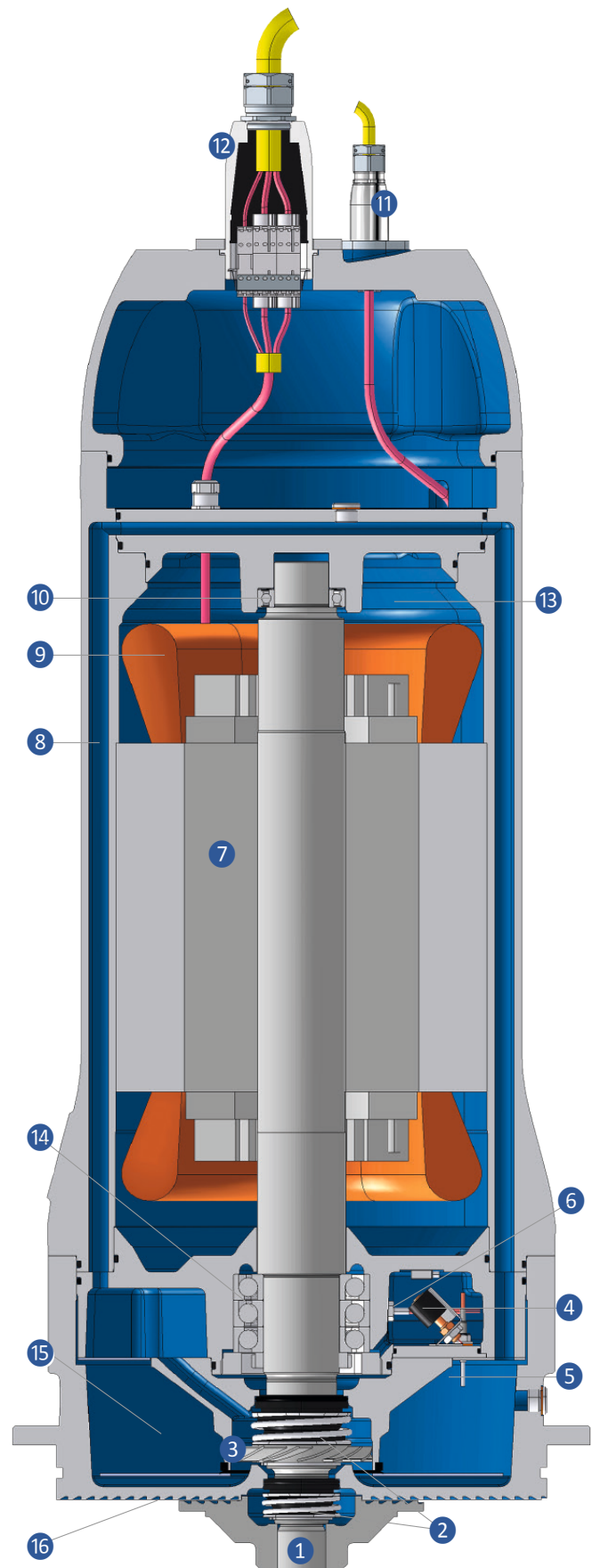

Tailor-made options

Explosion protection

Hidrostal Tuma motors are certified for applications in Ex zones 1 and 2 temperature classes T4, according to the requirements of IECEx, ATEX, FM and CSA. All motors are approved for operation with frequency converters.

Seal

Hidrostal offers a patented premium mechanical seal in addition to a high quality standard mechanical seal. The standard mechanical seal guarantees a very long service life and high reliability for the highest demands on the material combination. The balanced premium mechanical seal ensures improved properties and thus demonstrates particular strength in aggressive media and demanding applications.

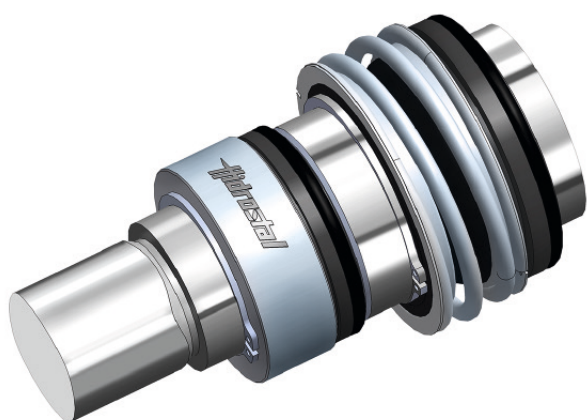

Accessories

A wide range of accessories completes the range. Various accessory options allow the optimum installation of Tuma motors on screw centrifugal pumps in both vertical and horizontal orientation. These include, for example, suspensions certified according to EN 13155, lowering devices and also base plates with and without pull-out slides.

Material versions

The Hidrostal motors are made of proven cast iron. For aggressive media, parts in contact with the medium or the complete motor can be manufactured in stainless duplex steel. This extends the service life of the components even in challenging applications. All elastomers can be individually adapted according to requirements and application.



Monitoring elements

For safe operation and effective protection of pump and system against damage, Hidrostral motors are equipped with various protection and monitoring elements. All measured signals are continuously evaluated in the control system, can trigger operating alarms or precautionary shutdowns, and allow scheduling preventive maintenance.

Winding monitoring

To protect the winding from overheating, bimetallic switches or PTC thermistors are fitted to the winding heads. With the optional PT100 sensors the winding temperature can be measured and evaluated.

Seal monitoring

For efficient protection of the electrical components and the roller bearings, Tuma submersible motors are equipped to ensure that both mechanical seals are permanently monitored. This is ensured by a conductivity probe for monitoring the medium-side seal and a float switch for checking the motor-side mechanical seal.

Vibration sensors

Vibration sensors (XYZ axis) monitor the condition of the vibration-emitting components of the motor and the mounted pump.

Bearing temperature monitoring

Optionally, both bearings can be monitored with PT100 sensors.

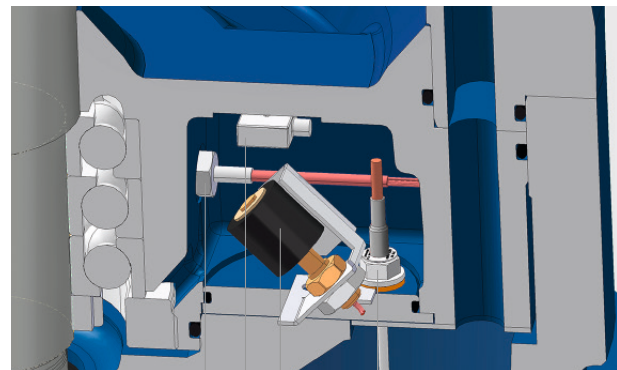

1 2 3 4

- ① Bearing temperature monitoring
- ② Vibration sensor
- ③ Float switch
- ④ Conductivity probe

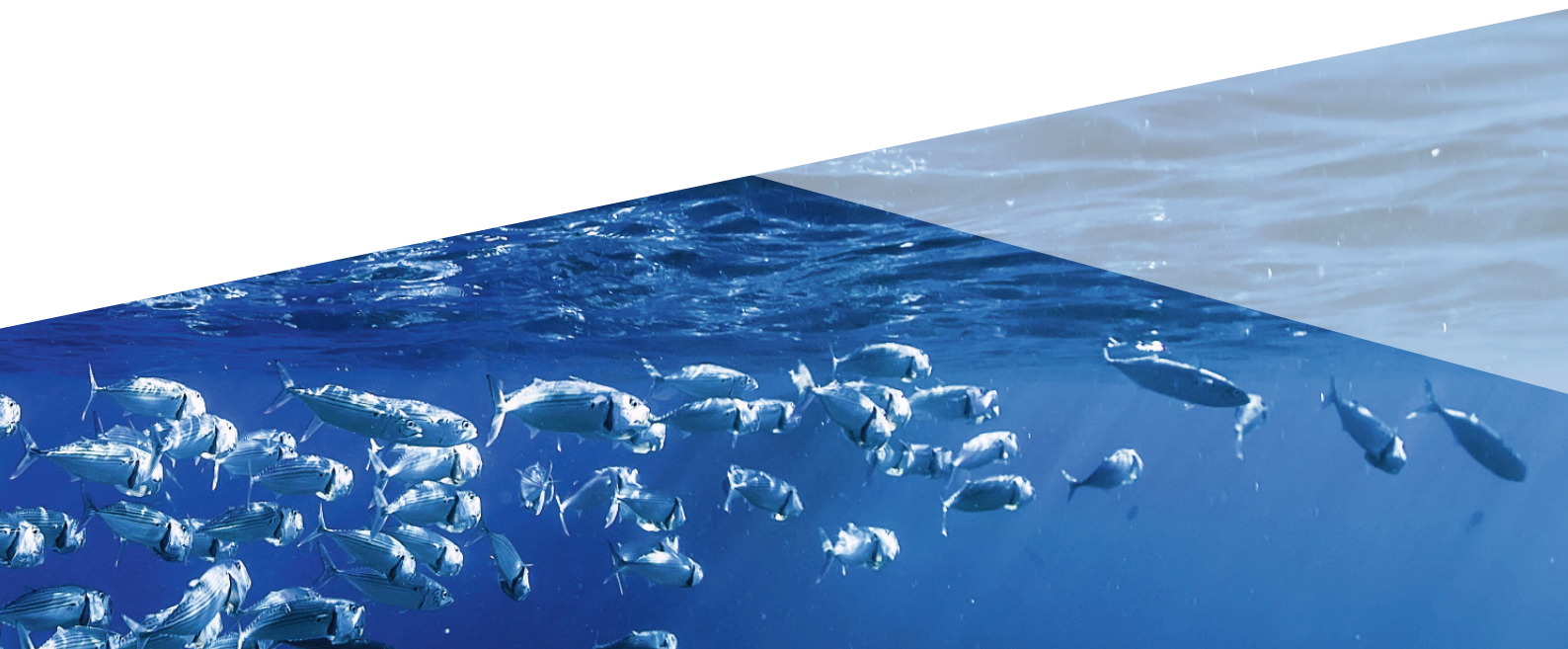

Hidrostal pumps

Make a quick and accurate pump selection:

www.hidrostal.com/pumpselector.php



Hidrostal pumps are used in numerous branches and industries due to their excellent pumping characteristics. They convey a wide variety of liquids and materials with low pulsation and gentle handling. Our specialists select the suitable material combinations and adapt each pump individually to the conditions on site. This approach ensures that Hidrostal pumps prove their worth even in difficult applications and thus achieve the best results in terms of efficiency, energy efficiency and low life cycle costs.

- non-clogging delivery
- high suction capacity
- gentle conveying due to low shear forces
- high efficiency
- stable characteristic curve
- long service life
- low pulsation
- continuous, speed proportional conveying
- high pressure stability

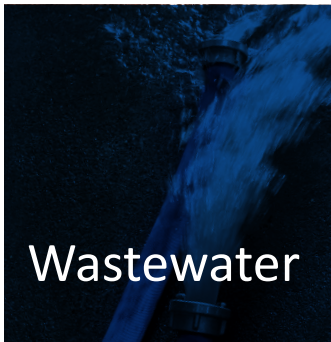

info@hidrostal.com
www.hidrostal.com

hidrostal
Pioneers in Pump Technology